

## *“Solutions within Reach”*

We provide consultancy services as well as design, engineering and manufacturing on a wide range of architectural hardware and extrusion products.

### GRILLE



# Grille

## Typical Assembly Details:

Group 1

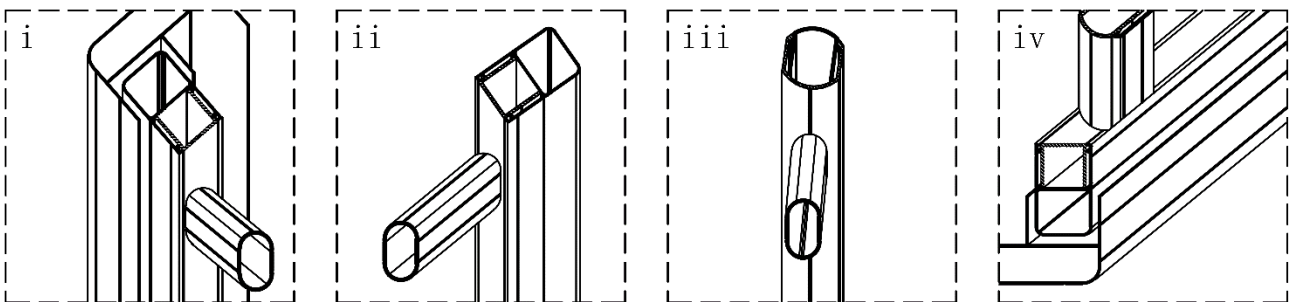
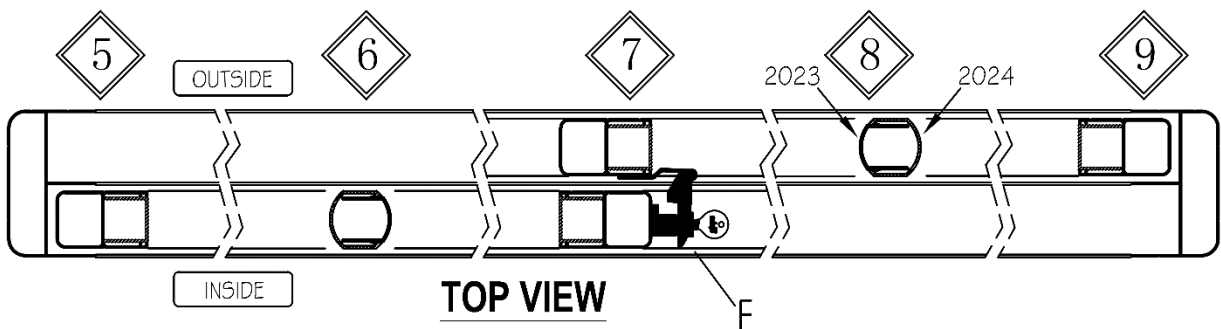
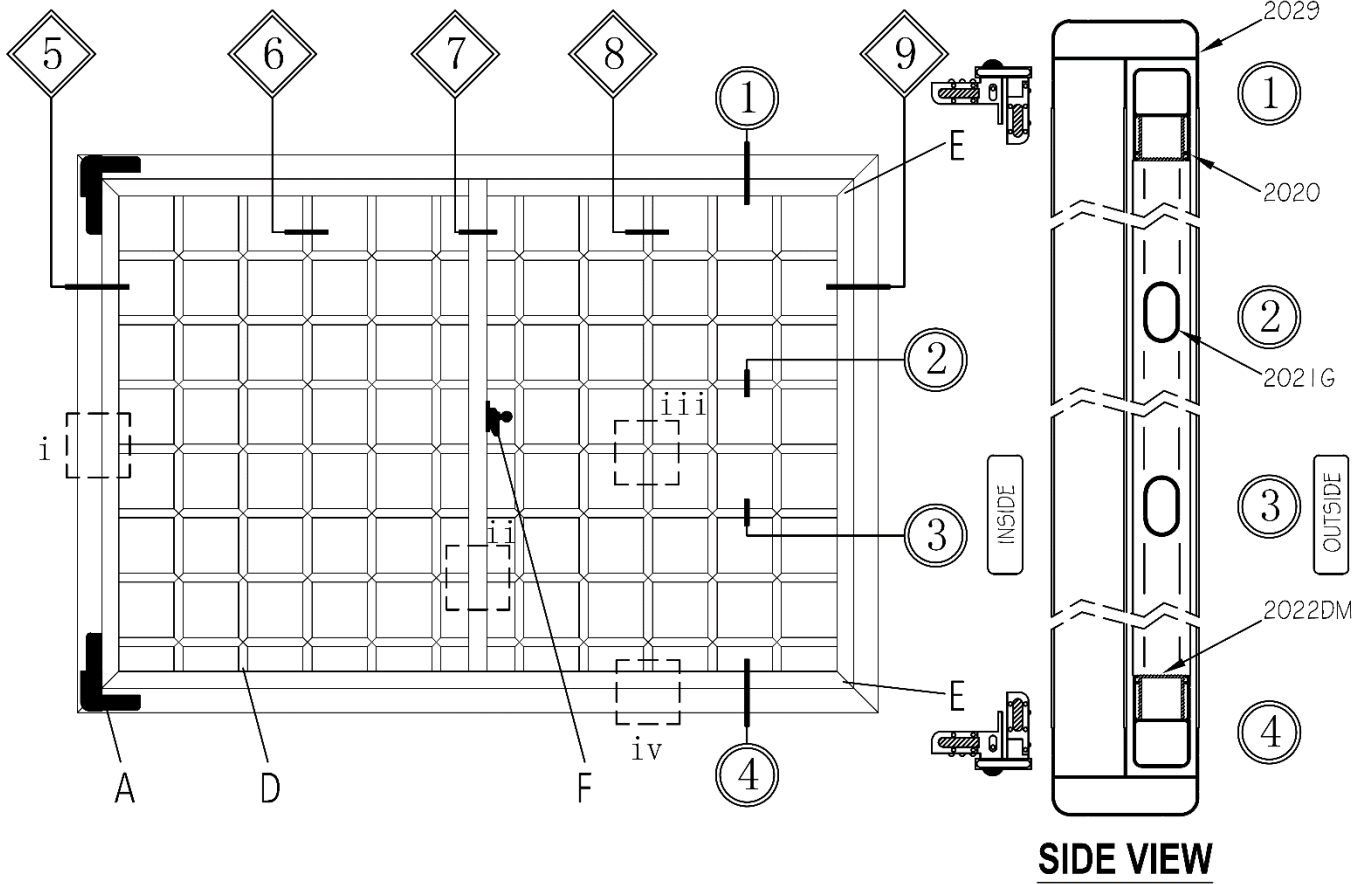

## Grille

### Sectional Details:

Group 1

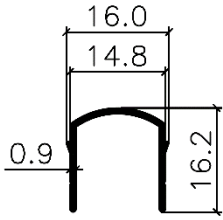

**2023**

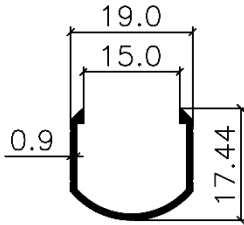

**2024**

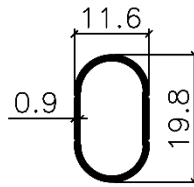

**2021G**

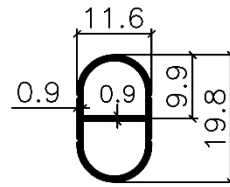

**2025G**

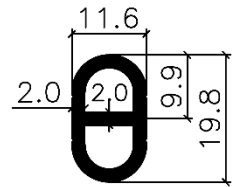

**2025XL**

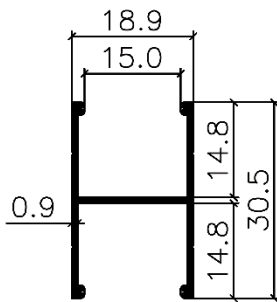

**2016M**

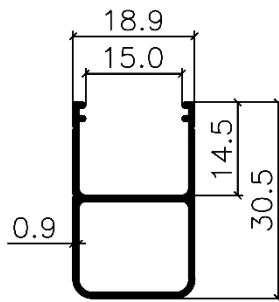

**2020**

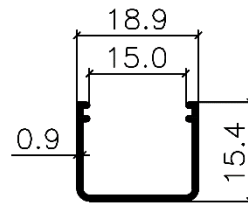

**2015M**

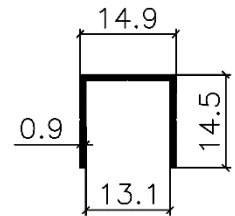

**2022DM**

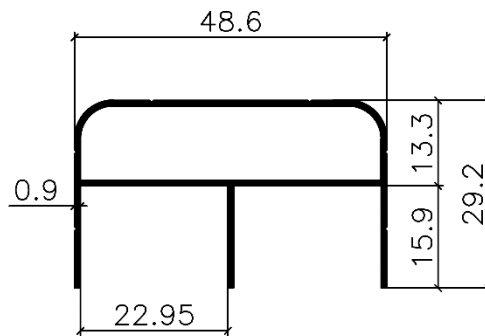

**2029**

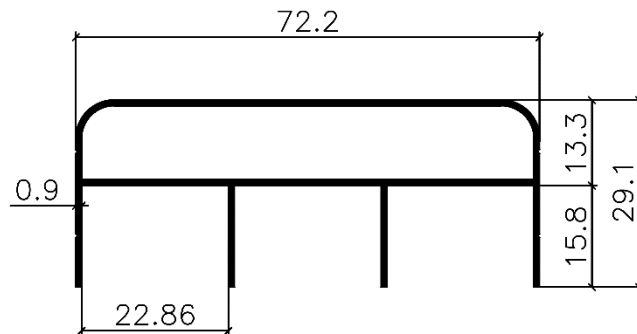

**2040M**

## Grille

### Hardware Accessories:

Group 1



A) 4452-2T



B) 4452-3T



C) 4454-F



D) 4455



E) 4453-WR



F) 4813



G) 4813SC



H) 4809M



I) 4817C-KA

# Grille

## Typical Assembly Details:

Group 2

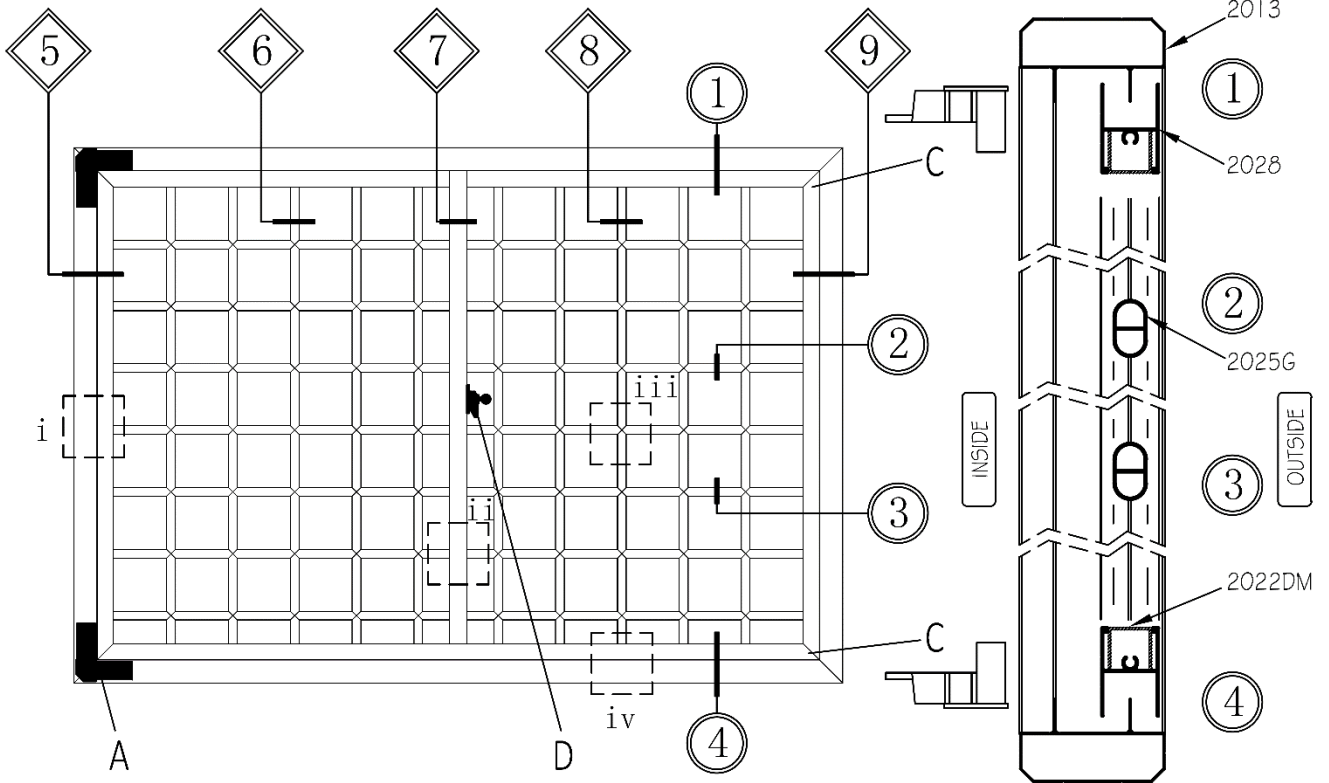

### SIDE VIEW

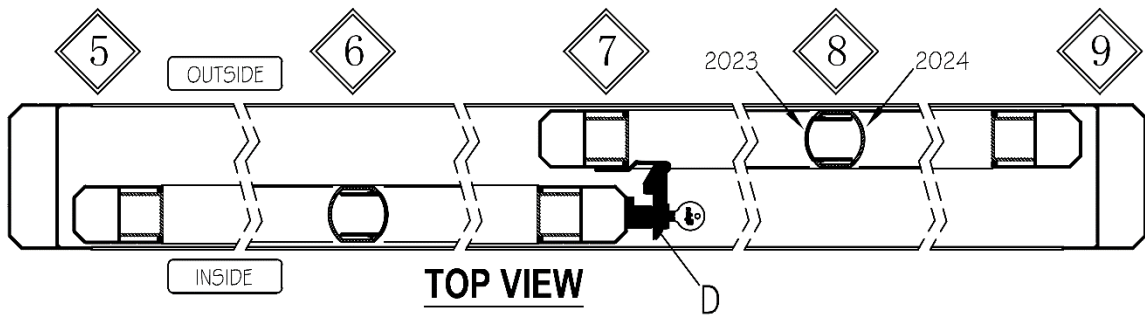

### TOP VIEW

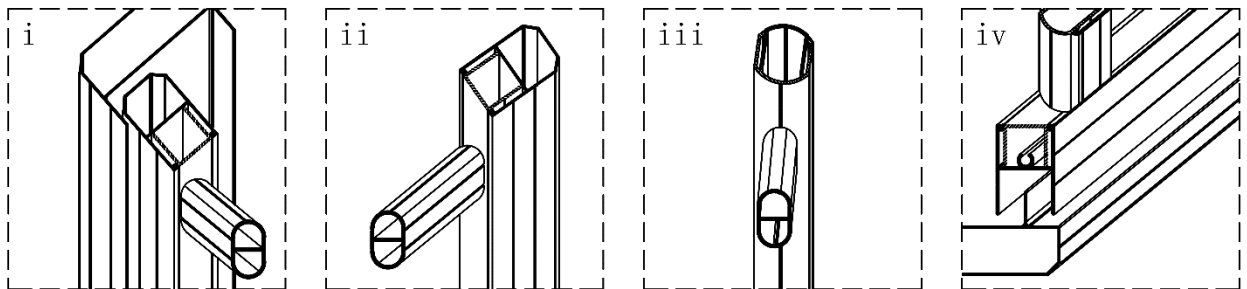

## Grille

### Sectional Details:

Group 2

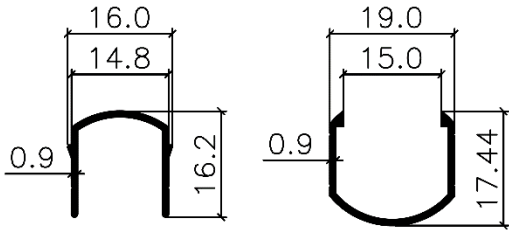

2023

2024

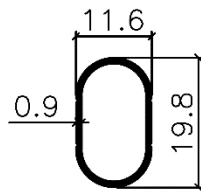

2021G

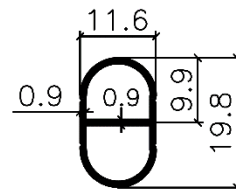

2025G

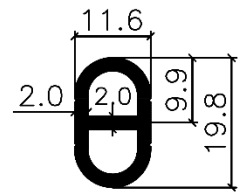

2025XL

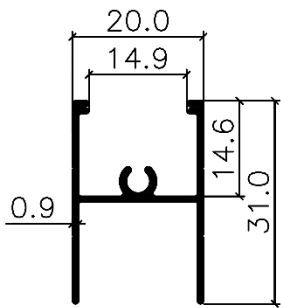

2028

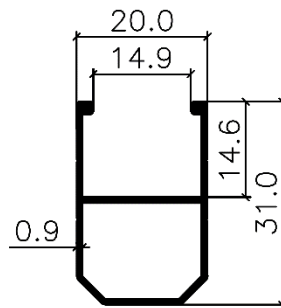

2027

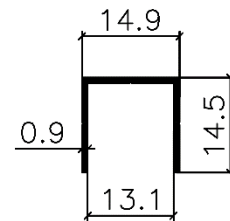

2022DM

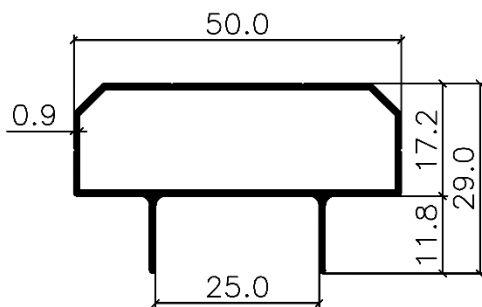

2013

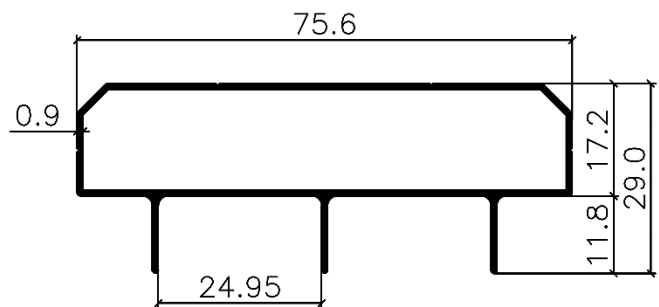

2011

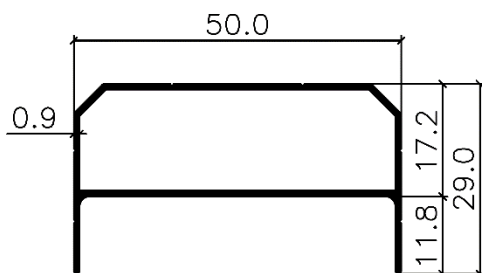

2014

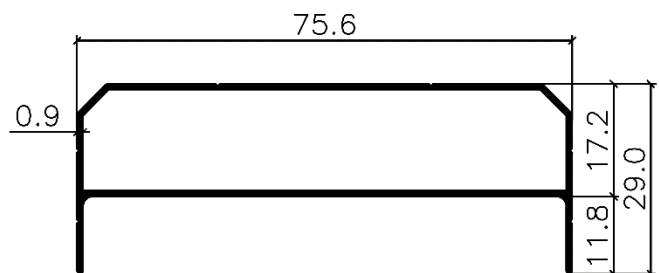

2012

## Grille

### Hardware Accessories:

Group 2

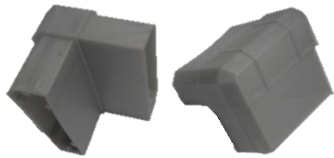

A) 4459-2T



B) 4459-3T



C) 4451



D) 4813



E) 4813SC



F) 4809M



G) 4817C-KA



**SINCE 1978**

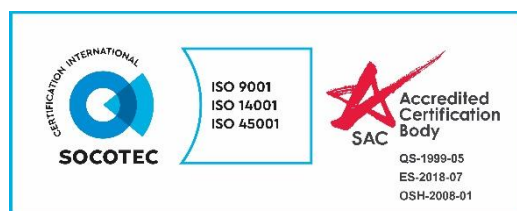

HQ Office:

12 Joo Koon Crescent,

Singapore 629013

Tel: 6745 0204

Fax: 6748 1741

Email: [sales@alphametals.com.sg](mailto:sales@alphametals.com.sg)

<http://www.alphametals.com.sg>

Branch:

Block 4023 #01-343/345/347,

Ang Mo Kio Ind. Park 1 Singapore 569634

Tel: 6455 5576

Fax: 6455 5587