

“Solutions within Reach”

We provide consultancy services as well as design, engineering and manufacturing on a wide range of architectural hardware and extrusion products.

CASEMENT WINDOW (CW70B)



CW70B Casement Window

Typical Assembly Details:

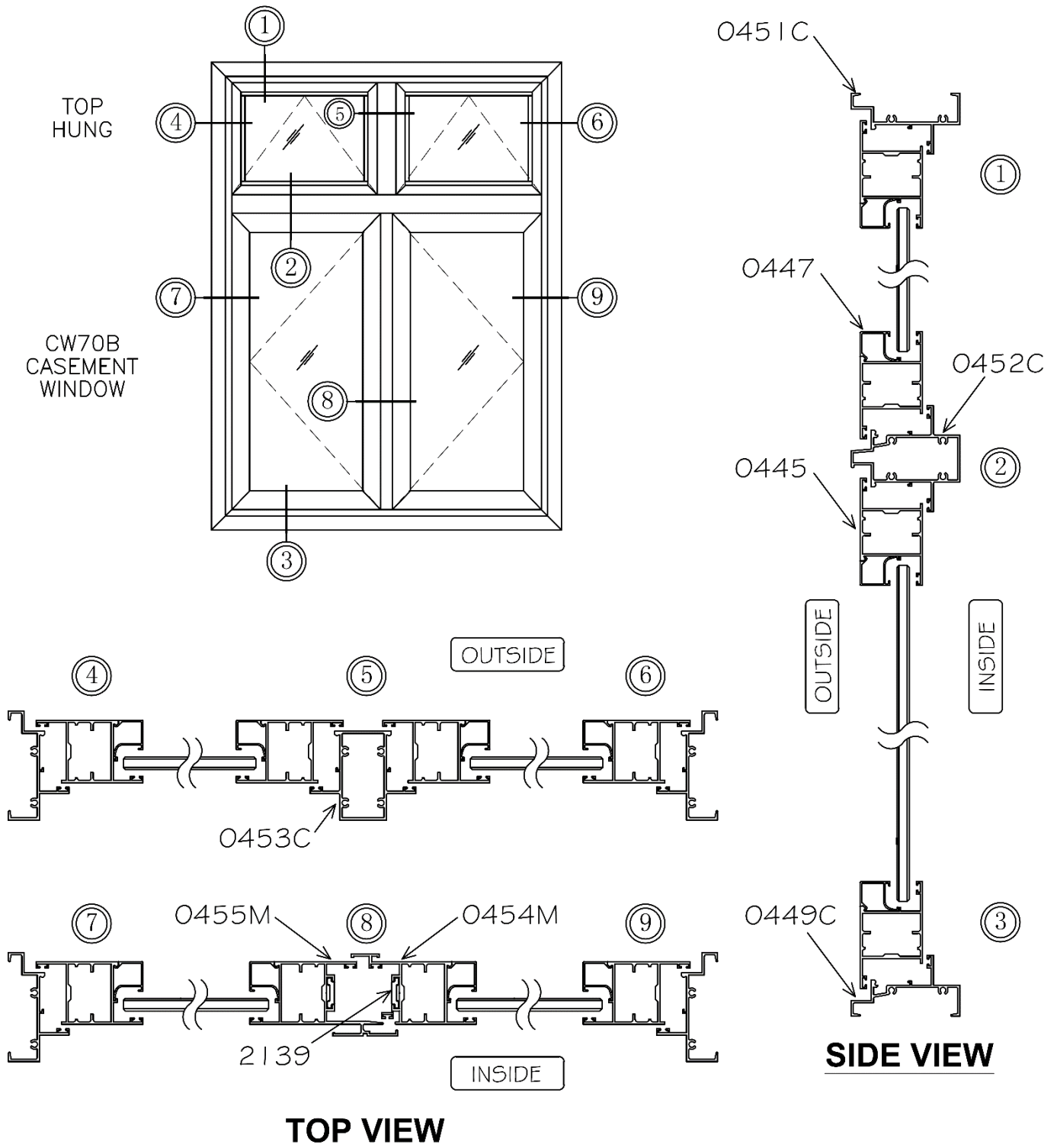

CW70B Casement Window

Sectional Details:

CW70B CASEMENT WINDOW (SERIES 1 & 2) (19MM BEADING)

OUTER

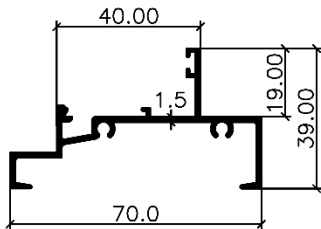

0449C

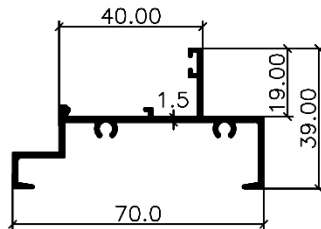

0451C

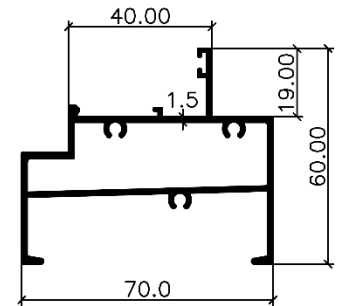

0451B

CW70B CASEMENT WINDOW (SERIES 2) (19MM BEADING)

MULLION

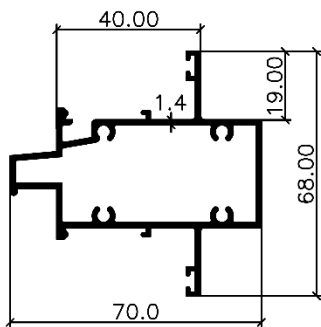

0452C

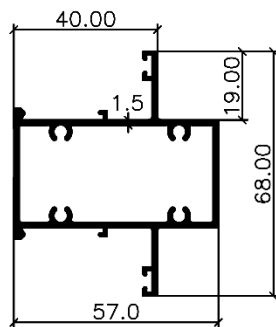

0453C

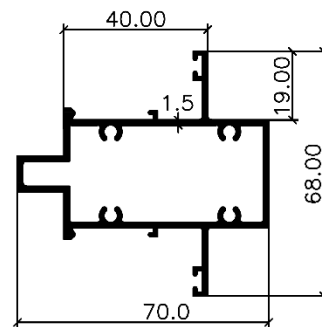

0457

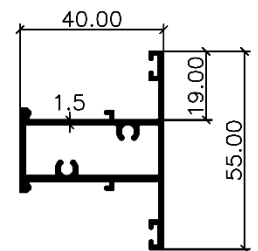

0438

CW70B CASEMENT WINDOW (SERIES 1, 2 & 3) (19MM BEADING)

BEADING

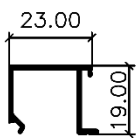

0441

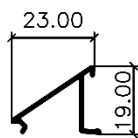

0442M

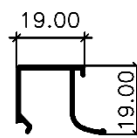

0447

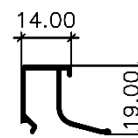

0444

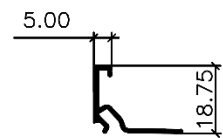

0446

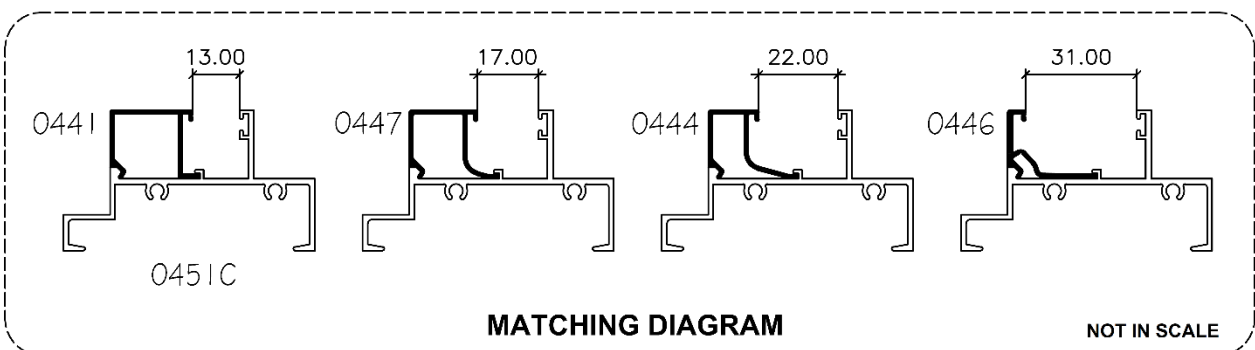

CW70B Casement Window

Typical Assembly Details:

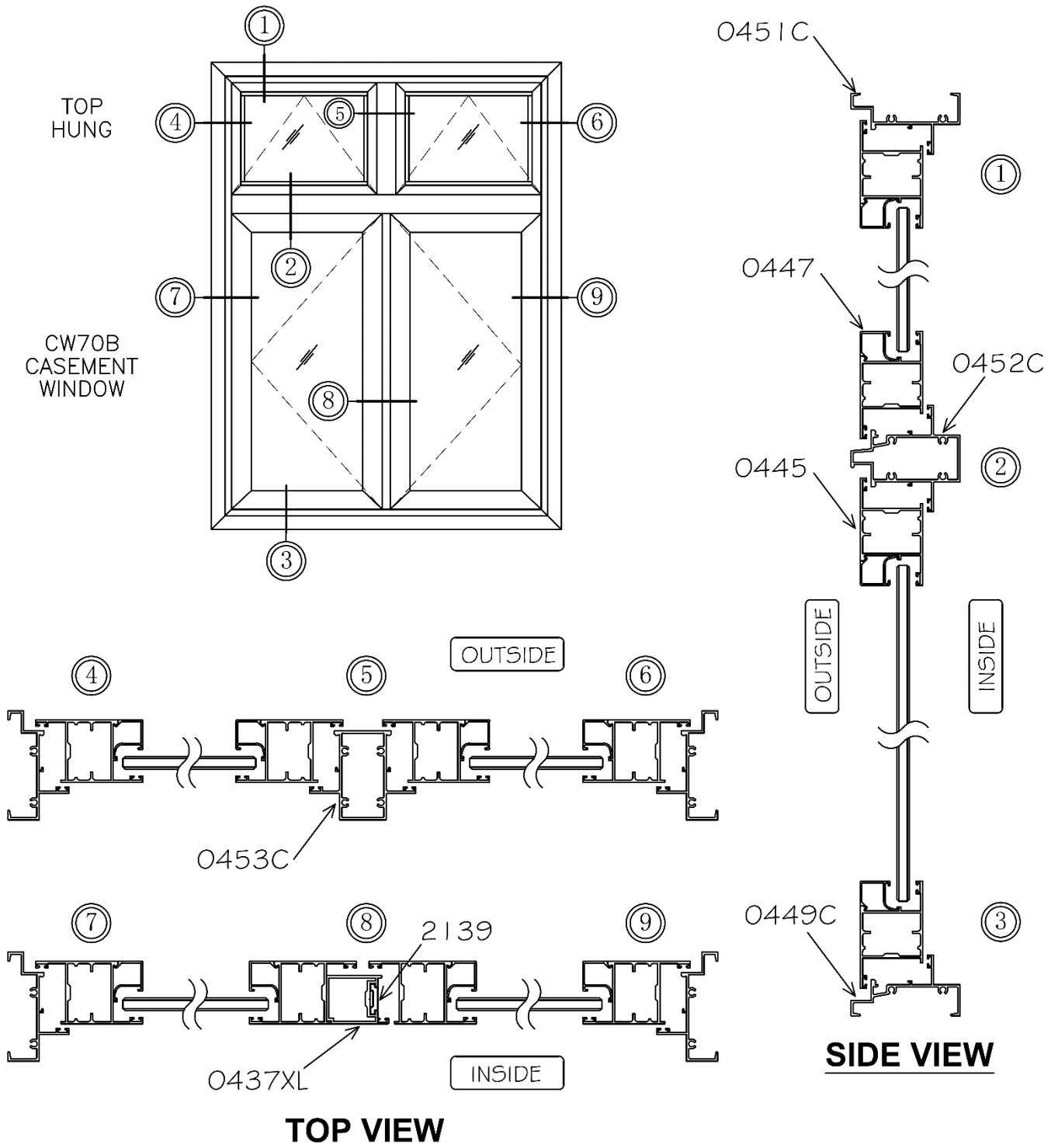

CW70B Casement Window

Typical Assembly Details:

CW70B CASEMENT WINDOW (SERIES 1 & 2) (19MM BEADING)

INNER

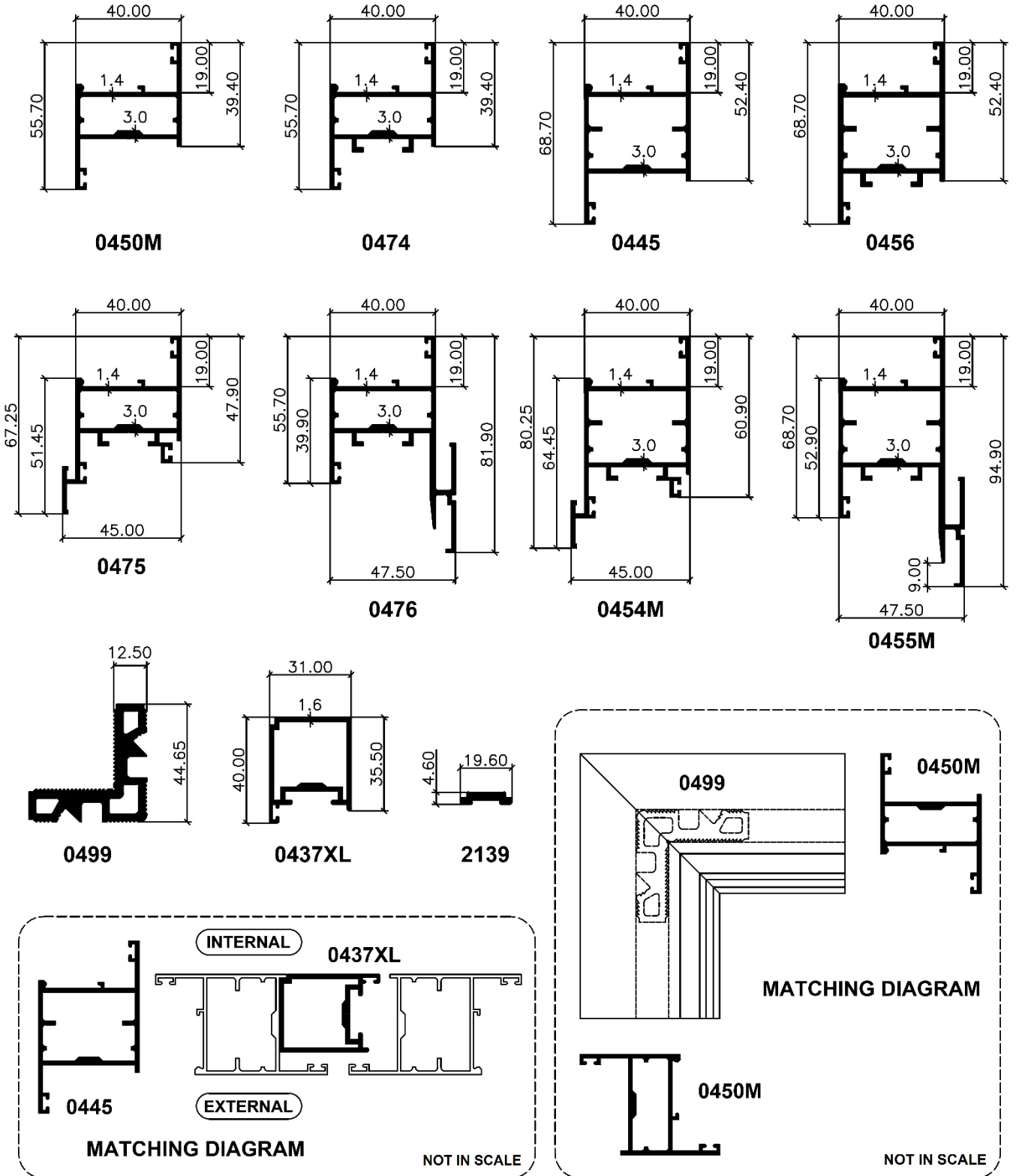

CW70B Casement Window

Sectional Details:

CW70B CASEMENT WINDOW (SERIES 3) (19MM BEADING)

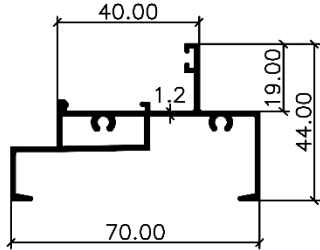

0459

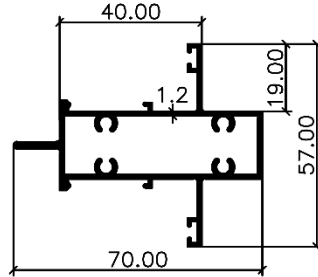

0460

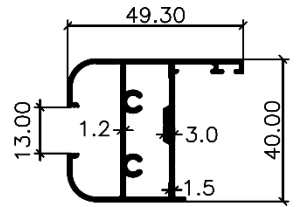

0461G

CW70B CASEMENT WINDOW MATCHING JOINT (SERIES 1~4)

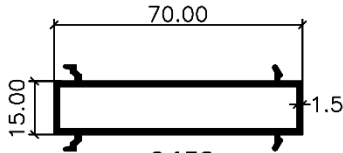

0458

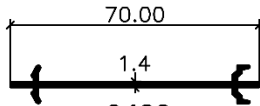

0439

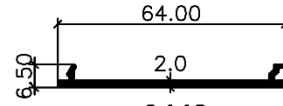

0448

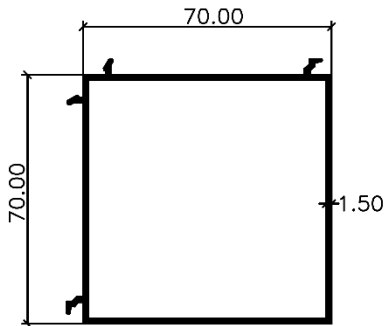

0466

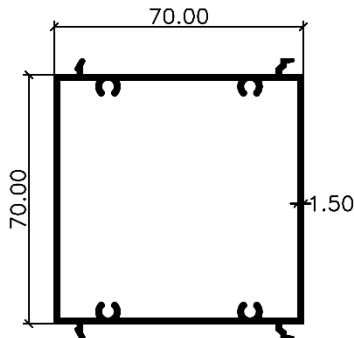

0535

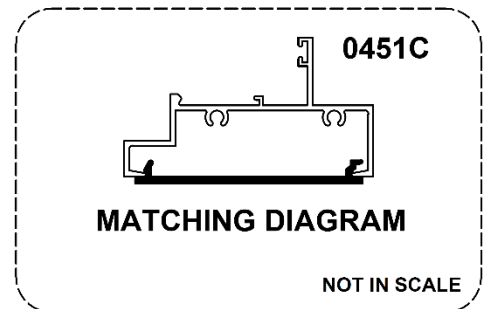

CW70B CASEMENT WINDOW (SERIES 2 & 4) (22MM BEADING)

BEADING

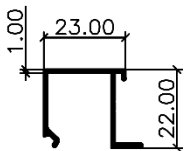

0465

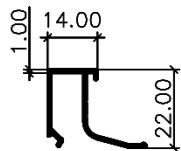

0468

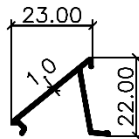

0469

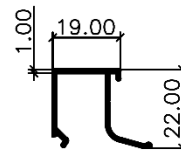

0579

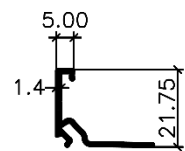

0479

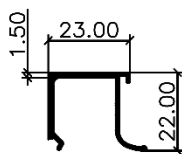

0590

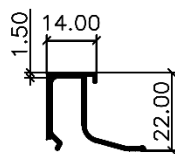

0589

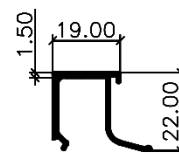

0588

CW70B Casement Window

Sectional Details:

CW70B CASEMENT WINDOW (SERIES 4) (22MM BEADING)

OUTER

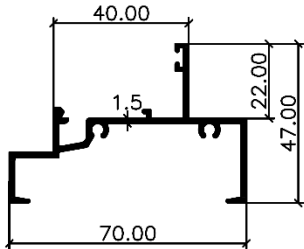

0477

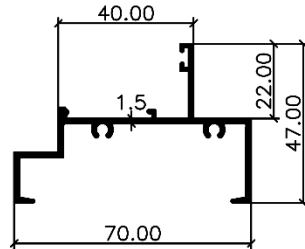

0478

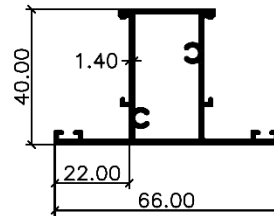

0436DS

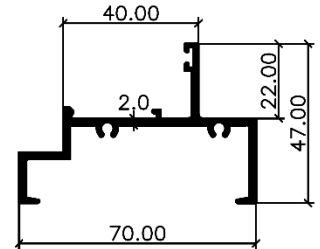

0462B

CW70B CASEMENT WINDOW (SERIES 4) (22MM BEADING)

MULLION

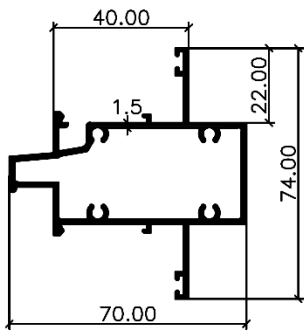

0463WG

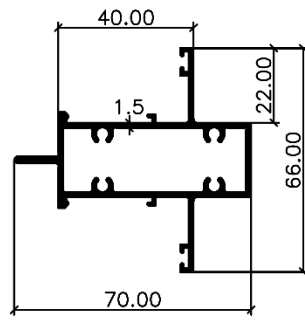

0463

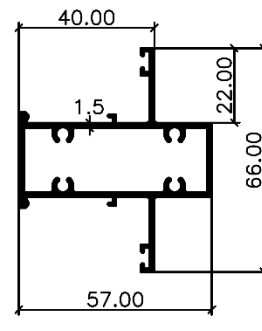

0470

CW70B CASEMENT WINDOW (SERIES 2 & 4) (22MM BEADING)

INNER

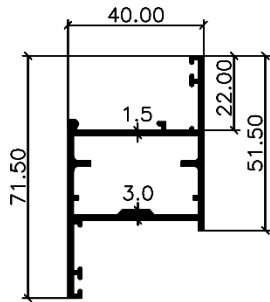

0472

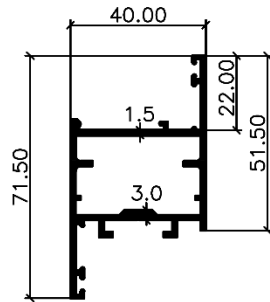

0473

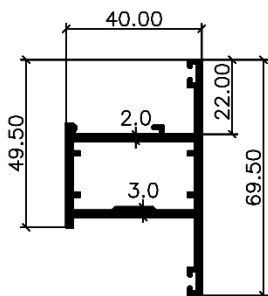

0464XL

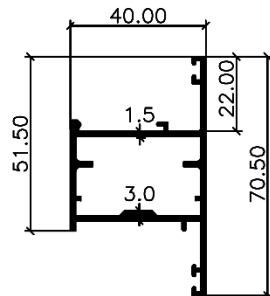

0583

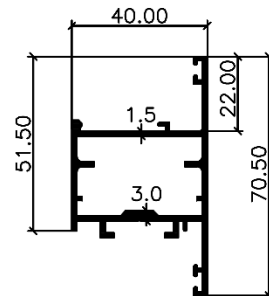

0584

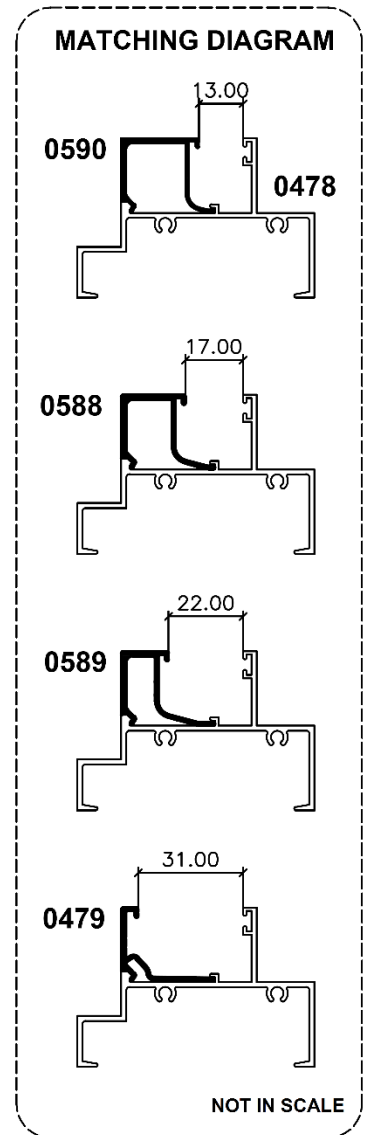

CW70B Casement Window

Hardware Fittings:

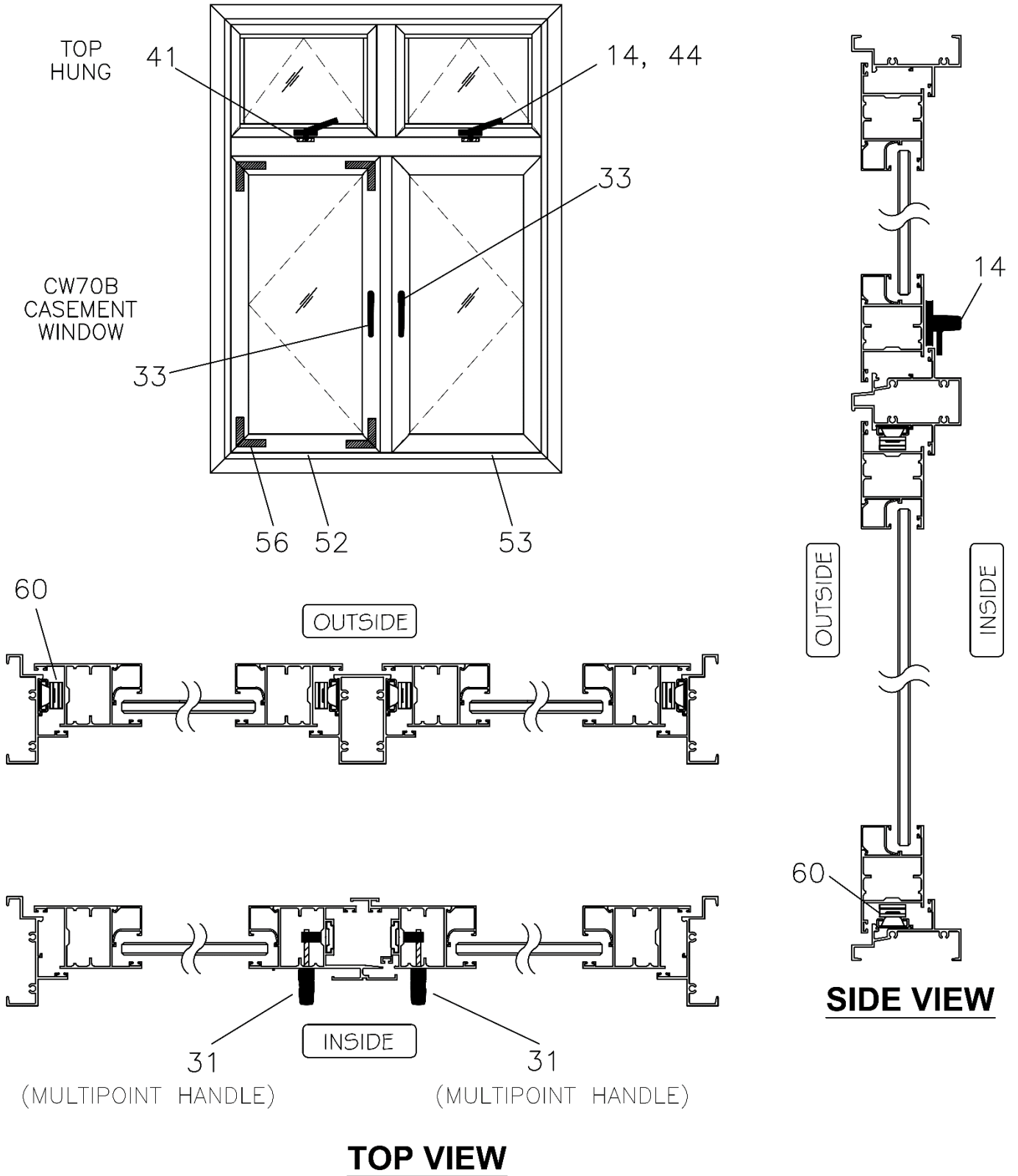

CW70B Casement Window

Hardware Accessories:



1) 4327C



2) 4328K



3) 4312



4) 4329AGS



5) 4323C



6) 4315PD



7) 4316PD



8) 4315MPA



9) 4322AG



10) 4315PDS



11) 4316PDS



12) 4338U



13) 4325PDS



14) 4309C



15) 4337U



16) 4337UB



17) 4337UKA



18) 4342



19) 4341C



20) 4334F



21) 4334FB



22) 4334FK



23) 5213F



24) 5213FB



25) 5213FK



26) 5215



27) 5215SD



28) 5201F



29) 5202FB



30) 5203FK



31) 5217



32) 5218

CW70B Casement Window

Hardware Accessories:

5200 Series Handles



PICTURE 1

5298 Accessories

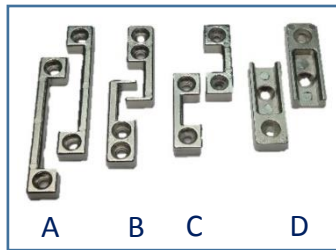

PICTURE 2

5296 Accessories

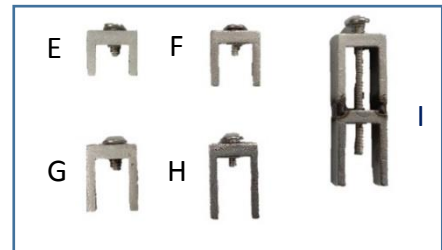

PICTURE 3

- | | | |
|------------|-------------|---|
| Picture 1: | CODE | : 5200 series handle x 1 piece (varieties of 5200 series handles shown below) |
| | Consists of | : BS009 Bolt head x 2 pieces |
| Picture 2: | A) CODE | : 5298-L45 x 2 pieces |
| | Description | : ALP/409/L45 CONNECTING PLATE MATCH ALP/95, ALP/215 & ALP/404 |
| | B) CODE | : 5298-L19 x 2 pieces |
| | Description | : ALP/410/L19 CONNECTING PLATE MATCH ALP/95, ALP/215 & ALP/404 |
| | C) CODE | : 5298-L15 x 2 pieces |
| | Description | : ALP/593/L15 CONNECTING PLATE MATCH ALP/95, ALP/215 & ALP/404 |
| | D) CODE | : 5298-L43 x 2 pieces |
| | Description | : ALP/592/L43 CONNECTING PLATE MATCH ALP/95, ALP/215 & ALP/404 |
| Picture 3: | E) CODE | : 5296-L15 x 2 pieces |
| | Description | : BS008/L15/RH10 S/S U-BRACKET FOR MULTIPOINT LOCK |
| | F) CODE | : 5296-L19 x 2 pieces |
| | Description | : BS008/L19/RH10 S/S U-BRACKET FOR MULTIPOINT LOCK |
| | G) CODE | : 5296-L22 x 2 pieces |
| | Description | : BS008/L22/RH10 S/S U-BRACKET FOR MULTIPOINT LOCK |
| | H) CODE | : 5296-L25 x 2 pieces |
| | Description | : BS008/L25/RH10 S/S U-BRACKET FOR MULTIPOINT LOCK |
| | I) CODE | : 5296-L50 x 2 pieces |
| | Description | : BS008/L50/RH10 S/S U-BRACKET FOR MULTIPOINT LOCK |

For example: Purchase of one set consists of Picture 1 Plus Picture 2 (A, B, C or D) Plus Picture 3 (E, F, G, H or I)



33) 5200-215



34) 5200-433
W/- BUTTON RELEASE



35) 5200-434
W/- KEY ALIKE & BUTTON RELEASE



36) 5200-611



37) 5200-95



38) 5200-424
W/- BUTTON RELEASE



39) 5200-423
W/- KEY ALIKE & BUTTON RELEASE



40) 5200-927
W/- KEY

CW70B Casement Window

Hardware Accessories:



41) 4456-H4



42) 4457A



43) 4458-T2.8

4458-T4.3

4458-T6.0

4458-T9.0



44) 8003-D1

8003-D2

8003-D3

8003-D4

8003-D7



45) 5091



46) 5094



47) 5095P



48) 5299-H08



49) 5299-H11



50) 4413M-BS129-BK



51) 4405M



52) 5295-H10



53) 5295-H12



54) 5294-H30



55) 5295CP-H16



56) 5046-331



47) 5299ZC-H11MM-CH



58) 4619-55C91-W16



59) 4617M-C90-W13

+

4699-BS232



60) 46-08A214-60D / 46-10A214-90D

46-12A214-90D / 46-14A214-90D

46-16A214-90D / 46-18A214-90D

46-20A214-50D / 46-24A214-50D



61) 46-08ALP520-60

46-10ALP520-90

46-12ALP520-90

46-14ALP520-90

46-16ALP520-90



62) 46-08B218-60D

46-10B218-90D

46-12B218-90D

46-14B218-90D

46-16B218-90D



63) 46-12A209-90D

46-16A209-90D

46-20A209-50D

46-20A209-90D

46-24A209-50D



64) 46-12B232-90D

46-18B232-90D



65) 46-12B231-35D

46-18B231-30D



66) 46-12B233-35D

46-16B233-35D

46-18B233-35D



67) 46-12ALP800-2P

46-14ALP800-2P

46-16ALP800-2P

46-18ALP800-2P



68) 5208L-RP-L300

5208L-RP-L600

5208L-RP-L900

5208L-RP-L1200



69) 5208R-RP-L300

5208R-RP-L600

5208R-RP-L900

5208R-RP-L1200



70) 5216TL-RP-L300

5216TL-RP-L600

5216TL-RP-L900



SINCE 1978

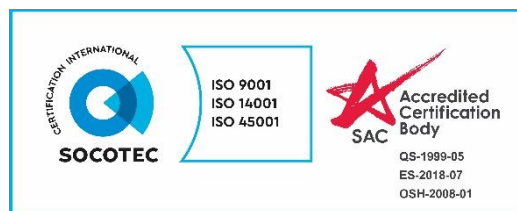

HQ Office:

12 Joo Koon Crescent,

Singapore 629013

Tel: 6745 0204

Fax: 6748 1741

Email: sales@alphametals.com.sg

<http://www.alphametals.com.sg>

Branch:

Block 4023 #01-343/345/347,

Ang Mo Kio Ind. Park 1 Singapore 569634

Tel: 6455 5576

Fax: 6455 5587